

Tussenvloer 1e - 2e etage

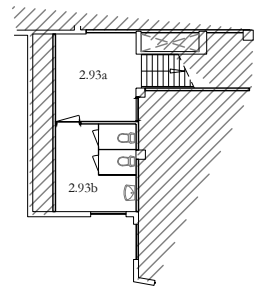

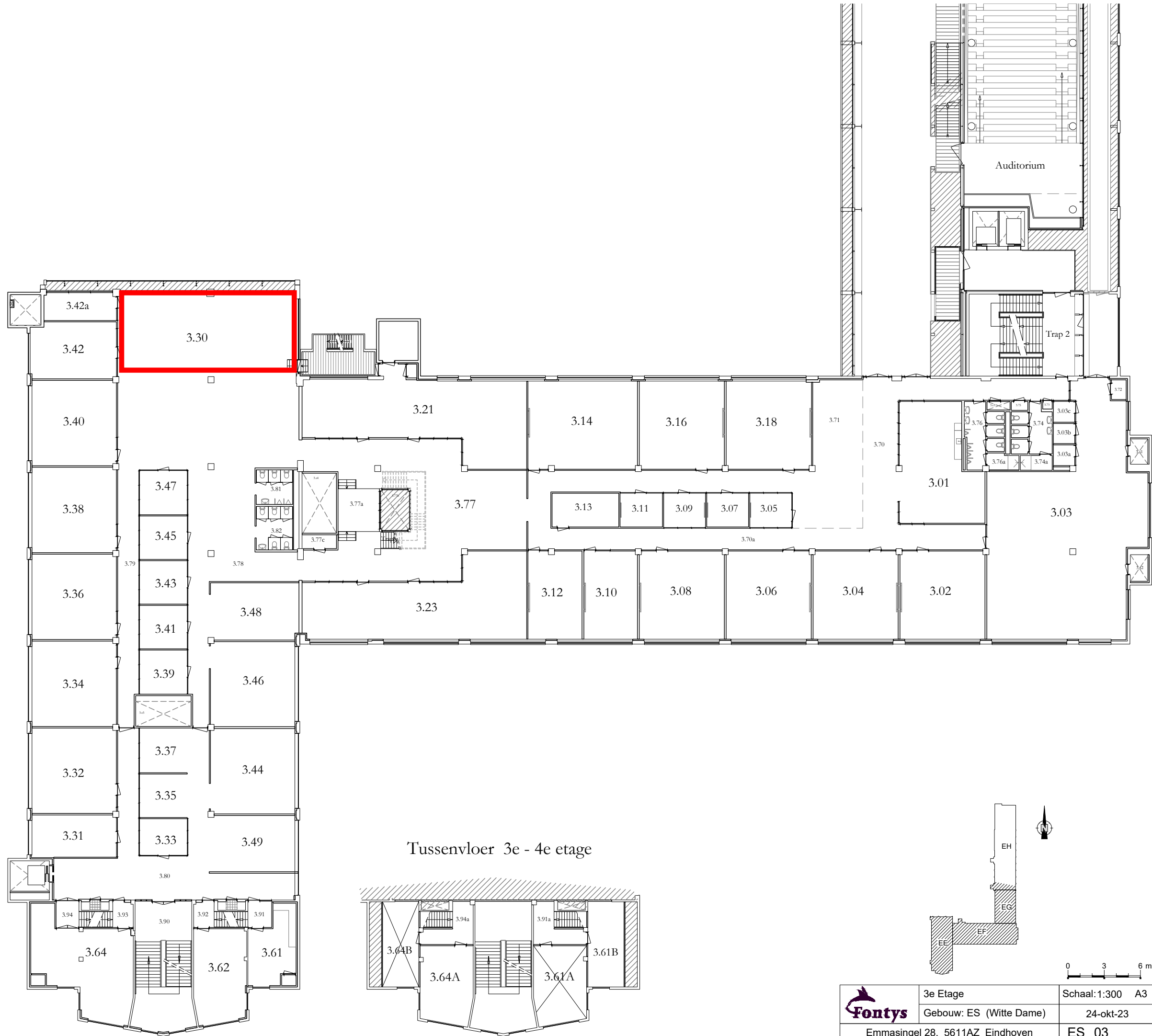

Tussenvloer 2e - 3e etage

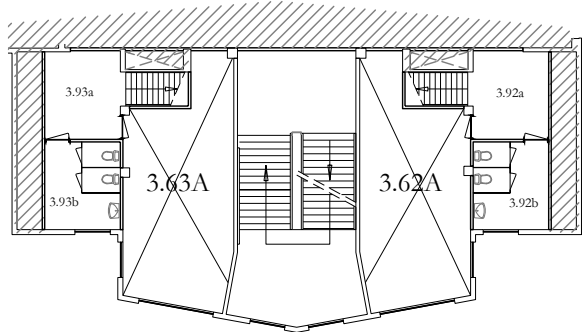

Tussenvloer 3e - 4e etage

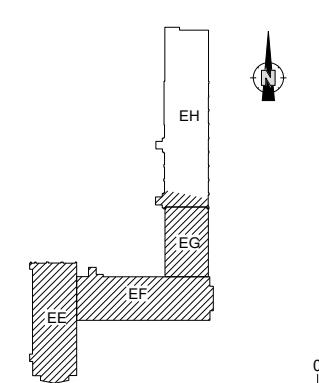
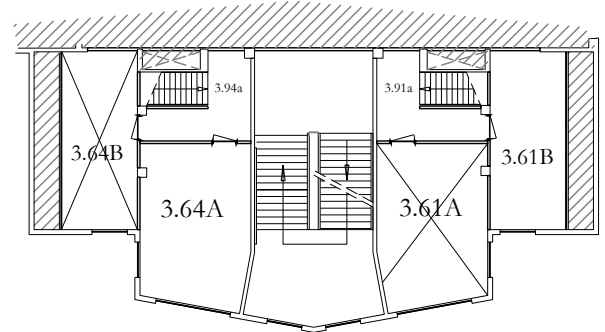

0 3 6 m

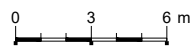
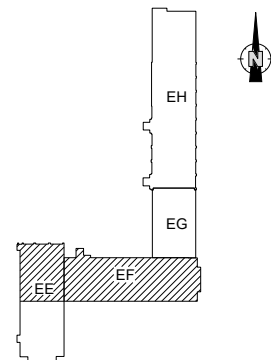
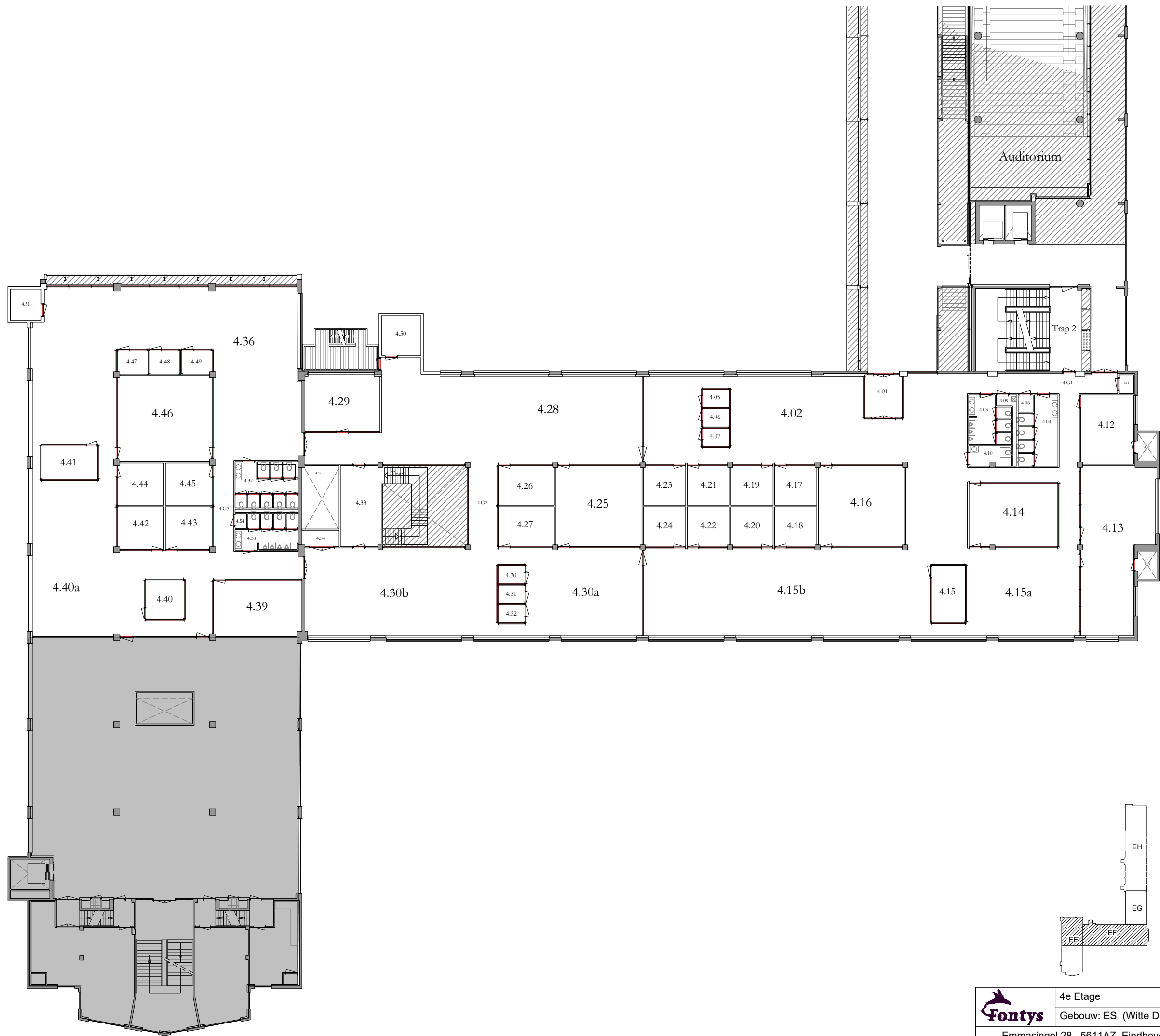

	4e Etage	Schaal: 1:300 A3
	Gebouw: ES (Witte Dame)	22-jan-16
	Emmasingel 28, 5611AZ Eindhoven	ES_04